

↗ DOMETIC

REFRIGERATION REFRIGERATORS



**RM 8xxx, RMS 8xxx, RML 8xxx,
RMSL 8xxx**

EN

Absorber refrigerator
Operating manual

Table of contents

1.0	General	4
1.1	Introduction	4
1.2	Guide to these operating instructions	4
1.3	Copyright protection	4
1.4	Explanation of symbols used in this manual	4
1.5	Warranty	5
1.6	Limitation of liability	5
1.7	Customer services	5
1.8	Spare parts	5
1.9	Environmental notices	6
1.9.1	Disposal	6
1.9.2	Energy-saving-tips	6
2.0	Safety instructions	7
2.1	Application according to regulations	7
2.2	User's responsibility	7
2.3	Protection of children when disposing of the equipment	7
2.4	Working upon and checking the refrigerator	7
2.5	Information on coolant	8
2.6	Operating the refrigerator with gas	8
2.7	Safety instructions when storing foodstuffs	9
3.0	Description of model	10
3.1	Model identification	10
3.2	Refrigerator rating plate	10
3.3	Technical data	11
3.4	Description of refrigerator	12
4.0	Refrigerator operation	13
4.1	Cleaning	13
4.2	Maintenance	13
4.3	Electrical operation	13
4.4	Gas operation	14
4.5	Explanation of operating controls	14
4.6	RM 8xx0 models	16
4.6.1	Electrical operation	16
4.6.2	Gas operation	16
4.6.3	Setting of cooling compartment temperature	16
4.7	RM 8xx1models	17
4.7.1	Electrical operation	17
4.7.2	Gas operation	17
4.7.3	Setting of cooling compartment temperature	17
4.8	RM 8xx5 models	17
4.8.1	Manual operation	17
4.8.2	Automatic operation	18
4.8.3	Setting of cooling compartment temperature	18
4.8.4	Refuelling while in AES mode operation	18
4.8.5	Additional features	18
4.9	Gas operation with internal batteries (optional)	19
4.9.1	Inserting / changing the batteries	19

4.10	Door locking	20
4.10.1	Fastening and releasing the door lock hook when parking the vehicle	20
4.11	Lighting	20
4.12	Positioning the storage racks	20
4.13	Removable freezer compartment	21
4.14	Exchange of the igniter's battery	21
4.15	Storing food and making ice cubes	22
4.15.1	Storing products in the cooling compartment	22
4.15.2	Storing products in the freezer compartment	22
4.15.3	Refrigerator compartments	22
4.15.4	Making ice cubes	23
4.16	Shutting off the refrigerator	23
4.17	Defrosting	23
4.18	Changing the decor panel	24
4.19	Troubleshooting	25
4.20	Information on failure display and trouble-shooting	26
4.20.1	Status indicators	26

Dometic GmbH
In der Steinwiese 16
D-57074 Siegen

www.dometic.com

1.0 General

1.1 Introduction

You have made an excellent choice in selecting the **Dometic** Absorption Refrigerator. We are sure that you will be satisfied with your new refrigerator in all respects. The refrigerator, which works silently, meets high quality standards and guarantees the efficient utilisation of resources and energy throughout its entire life cycle, during manufacture, in use and when being disposed of.

1.2 Guide to these operating instructions

Before you start using the refrigerator, please read the operating instructions carefully.

These instructions provide you with the necessary guidance for the proper use of your refrigerator. **Observe in particular the safety instructions.** Observation of the instructions and handling recommendations is important for dealing with the refrigerator safely and for protecting you from injury and the refrigerator from damage. You must understand what you have read before you carry out a task.

Keep these instructions in a safe place close to the refrigerator so they may be referred to at any time.

1.3 Copyright protection

The information, texts and illustrations in these instructions are copyright protected and are subject to industrial property rights. No part of these instructions may be reproduced, copied or utilised in any other way without written authorisation by Dometic.

1.4 Explanation of symbols used in this manual

Warning notices

Warning notices are identified by symbols. A supplementary text gives you an explanation of the degree of danger.

Observe these warning notices rigorously. You will thus protect yourself and other people from injury, and the appliance from damage.



DANGER!

DANGER indicates an imminent hazardous situation which, if not avoided, could result in death or serious injury.



WARNING!

WARNING indicates a potentially hazardous situation which, if not avoided, could result in death or serious injury



CAUTION!

WARNING indicates a potentially hazardous situation which, if not avoided, could result in death or serious injury

CAUTION!

CAUTION (used without the safety alert symbol) indicates a potentially hazardous situation which, if not avoided, may result in damage to the appliance.

Information



INFORMATION gives you supplementary and useful guidance when dealing with your refrigerator.

Environmental Tips



ENVIRONMENTAL TIPS gives you useful guidance for saving energy and disposal of the appliance.

1.5 Warranty

Warranty arrangements are in accordance with the normal conditions applicable for the country concerned. For warranty or other maintenance, please contact our customer services department. Any damage due to improper use is not covered by the warranty. The warranty does not cover any modifications to the appliance or the use of **non-original Dometic** parts. The warranty does not apply if the installation and operating instructions are not adhered to and no liability shall be entertained.

1.6 Limitation of liability

All information and guidance in these operating instructions were prepared after taking into consideration the applicable standards and regulations as well as the current state of the art. **Dometic** reserves the right to make changes at any time which are deemed to be in the interest of improving the product and safety.

Dometic will assume no liability for damage in the case of :

- non-observation of the operating instructions
- application not in accordance with the regulations or provisions
- use of non-original spare parts
- modifications and interferences to the appliance
- effect of environmental influences, such as
 - temperature fluctuations
 - humidity

1.7 Customer services

Dometic offers a service dealer network . You can obtain the address information of the nearest customer service from **www.dometic.com**. When contacting Dometic Customer Services, please state the model, product number and serial number together with the MLC code, if applicable. You will find this information on the rating plate inside the refrigerator. We recommend that you note this data in the field provided on the front page of this operation manual.

1.8 Spare parts

Parts can be ordered throughout Australia and New Zealand from our service dealer network.

Always give the model and product number when you contact the customer service! You will find this information on the rating plate inside the refrigerator.

1.9 Environmental notices



Refrigerators manufactured by Dometic are free of CFC/HCFC and HFC. Ammonia (a natural compound of hydrogen and nitrogen) is used in the cooling unit as a coolant. Non-ozone-hazardous cyclopentane is used as a propellant for manufacturing PU foam insulation.

1.9.1 Disposal

In order to ensure that the recyclable packaging materials are re-used, they should be sent to the customary local collection system. The appliance should be transferred to a suitable waste disposal company that will ensure re-use of the recyclable components and proper disposal of the rest. For eco-friendly draining of the coolant from all absorber refrigeration units, a suitable disposal plant should be used.

1.9.2 Energy-saving-tips

- At an average ambient temperature of 25°C, it is sufficient to operate the refrigerator at middle thermostat setting.
- Where possible, always store precooled products.
- Do not expose the refrigerator to direct sunlight.
- Ensure that air circulation of the cooling unit is not obstructed.
- Defrosting at regular intervals saves energy (see section 4.7 "Defrosting").
- Open the refrigerator door only for a short period of time when removing products. Run the refrigerator for about 12 hours before filling it.

2.0 Safety instructions

2.1 Application according to regulations

This refrigerator is designed for installation in recreation vehicles such as caravans or motorhomes.

The refrigerator is to be used solely for storing foodstuffs.



WARNING!

The refrigerator is not suitable for the proper storage of medication. Please observe in addition the instructions in the medication package inserts.

2.2 User's responsibility

Anyone operating the refrigerator must be familiar with the safe handling and understand the advice in these operating instructions.

This appliance is not intended for use by persons (including children) with reduced physical, sensory or mental capabilities, or lack of experience and knowledge, unless they are supervised or have been given instruction concerning use of the appliance by a person responsible for their safety. Children should be supervised to ensure that they do not play with the appliance. Cleaning and user maintenance shall not be made by children.

2.3 Protection of children when disposing of the equipment



WARNING!

When disposing of the refrigerator, detach all refrigerator doors and leave the storage racks in the refrigerator. In this way inadvertent entrapment and suffocation is prevented.

2.4 Working upon and checking the refrigerator



WARNING!

Work on gas equipment, exhaust system and electrical facilities must be carried out by authorised personnel only. Substantial damage to property and/or injury to persons can arise through unprofessional procedures.



DANGER!



Never use an unshielded flame to check gas bearing parts and pipes for leakage!

There is a danger of fire or explosion.



WARNING!

Never open the absorber cooling unit! It is under high pressure.

There is a danger of injury!

2.5 Information on coolant

Ammonia is used as a coolant.

This is a natural compound also used in household cleaning agents (1 litre of Salmiak cleaner contains up to 200g of ammonia - about twice as much as is used in the refrigerator). Sodium chromate is used for corrosion protection (1.8% by weight of the solvent).

In the event of leakage (easily identifiable from the strong odour), proceed as follows:

- Switch off the appliance.
- Air the room thoroughly.
- Inform authorised customer services.



For your safety it was ascertained in an expert's report that no impairment of health exists when the coolant is discharged.

2.6 Operating the refrigerator with gas

It is imperative that the operating pressure corresponds to the data specified on the rating plate of the appliance. Compare the operating pressure of the rating plate with the data specified on the pressure reducing valve of the liquid gas cylinder.



WARNING!

Operating the appliance with gas is not permitted

- **at petrol stations**
- **on ferry boats**
- **while transporting the caravan/motor-home by a transporter or breakdown vehicle.**

There is the danger of fire!

Leave the equipment switched off.

If you smell gas:

- Open all windows and leave the room.
- Do not operate any electrical equipment and prevent the use of naked flames.
- Do not operate any electrical equipment and prevent the use of naked flames.
- Contact authorised specialist personnel* for advice.

*** authorised specialist personnel**

Authorised specialist personnel are accredited experts who are able, by virtue of their training and knowledge, to vouch that the inspection and repair work has been carried out properly.

2.7 Safety instructions when storing foodstuffs

No refrigerator of any kind can improve the quality of the food; refrigerators can only maintain the food's quality for a short duration as from the time of storing it.

Please observe the following particular conditions for storing food in a refrigerator that is built into a vehicle:

- A change in the climatic conditions such as temperature fluctuations
- High temperatures inside the vehicle when it is closed and parked in direct sunlight (temperatures are possible up to 50°C)
- Use of the refrigerator during travel with the power supply of 12V DC
- A refrigerator built in behind a window and exposed to direct sunlight
- Storing the products too soon, i.e. shortly after starting up the appliance for use

Under these particular conditions the refrigerator cannot guarantee reaching the temperature needed for perishables.

Perishables include all products with a stipulated use-by date and a minimum storage temperature of +4°C or less, especially for meat, poultry, fish, sausages, pre-packed foods.

- Pack raw and cooked foods separately (e.g. in containers, aluminium foil, etc.).
- Only remove the outside packaging of single packs if all the necessary information, e.g. the use-by date, can also be read on the single packs.
- Do not leave cooled goods outside the refrigerator for too long.
- Place the foods with the next use-by date at the front, accordingly.
- Pack away any left-over food and eat at the first opportunity.
- Wash your hands before and after handling any food.
- Regularly clean the inside of the refrigerator.

Please observe the instructions and information regarding the use-by date on the outside packaging of the food.

Please observe section "4.1 Cleaning" of this instruction.



The cooling unit's performance is influenced by ambient temperatures. Please select the medium setting for ambient temperatures between +15°C and +25°C (refer to *Setting of cooling compartment temperature*). The unit operates within its optimum performance range.

Dometic refrigerators work according to the absorption principle. For physical reasons, an absorption system responds slowly to changes made by the thermostat controller, by loss of cooling energy through opening the door or during storing food. The devices meet the cooling performance requirements of the Climatic Class SN acc. to EN/ISO 7371 in the temperature range of +10°C to +32°C ambient temperature.

3.0 Description of model

3.1 Model identification

Example :

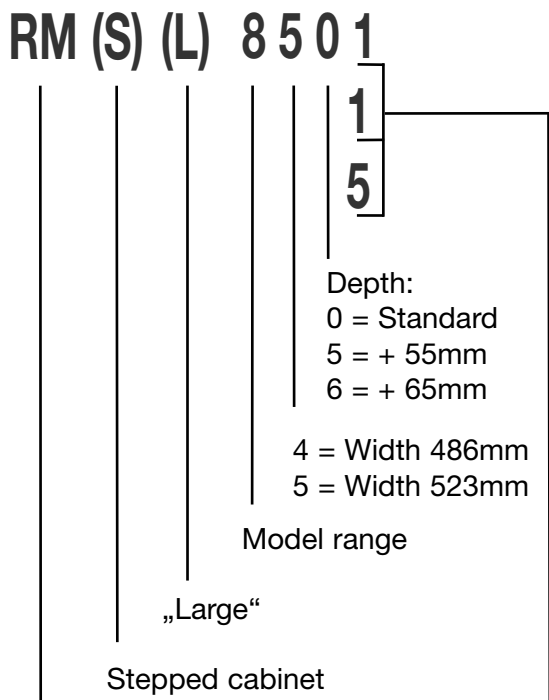

Refrigerator Mobile /
 Mobile Absorption Refrigerator

- ↓
- 0
 manual energy selection + manual ignition
(battery igniter)
 - 1
 manual energy selection, automatic ignition
(MES)
 - 5
 automatic and manual energy selection,
 automatic ignition **(AES)**

3.2 Refrigerator rating plate

The rating plate is to be found on the inside of the refrigerator. It contains all important details of the refrigerator. You can read off from this the model identification, the product number and the serial number. You will need these details whenever you contact the customer service centre or when ordering spare parts.

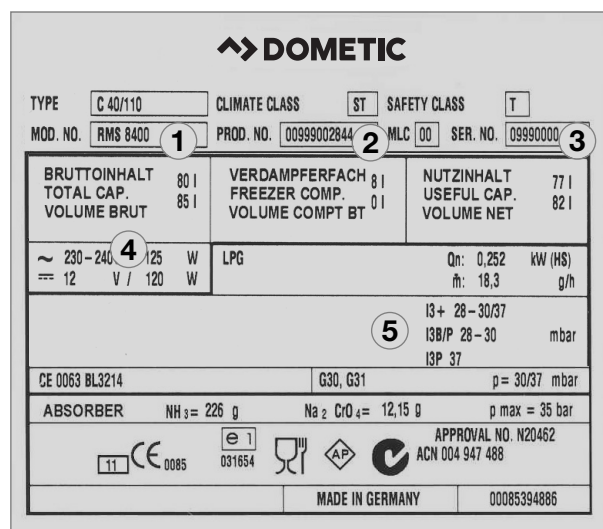

Fig. 1

Example

- 1** Model number
- 2** Product number
- 3** Serial number
- 4** Electrical rating details
- 5** Gas pressure

3.3 Technical data

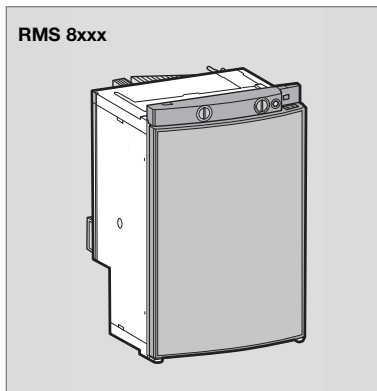

Fig. 2

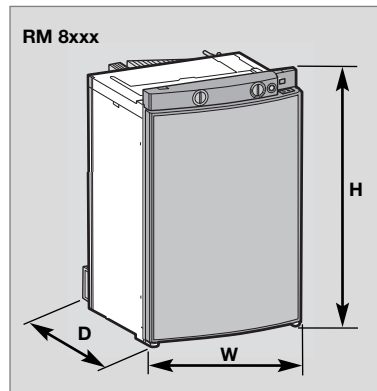

Fig. 3

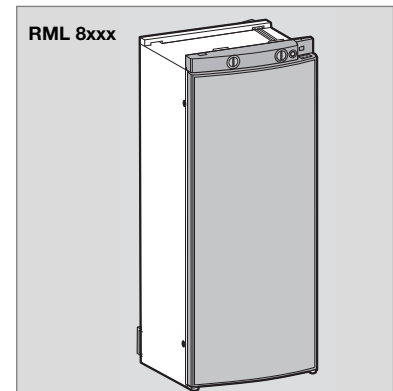

Fig. 4

Models with curved door

Model	Dimensions H x W x D (mm) Depth incl. door	Gross capacity with freezer compartment	without freezer compartment	Rating details mains/battery	Consumption * electricity/gas over 24hrs	Net weight	Ignition Piezo	Automat
RMS 8400	821x486x568	80 / 8 lit.	85 lit.	125 W / 120 W	ca.2,5 KWh / 270 g	25 kg	•	
RMS 8401	821x486x568	80 / 8 lit.	85 lit.	125 W / 120 W	ca.2,5 KWh / 270 g	25 kg		•
RMS 8405	821x486x568	80 / 8 lit.	85 lit.	125 W / 120 W	ca.2,5 KWh / 270 g	25 kg		•
RM 8400	821x486x568	90 / 8 lit.	95 lit.	135 W / 130 W	ca.2,4 KWh / 270 g	27 kg	•	
RM 8401	821x486x568	90 / 8 lit.	95 lit.	135 W / 130 W	ca.2,4 KWh / 270 g	27 kg		•
RM 8405	821x486x568	90 / 8 lit.	95 lit.	135 W / 130 W	ca.2,4 KWh / 270 g	27 kg		•
RMS 8460	821x486x633	90 / 11 lit.	96 lit.	125 W / 120 W	ca.2,5 KWh / 270 g	26 kg	•	
RMS 8461	821x486x633	90 / 11 lit.	96 lit.	125 W / 120 W	ca.2,5 KWh / 270 g	26 kg		•
RMS 8465	821x486x633	90 / 11 lit.	96 lit.	125 W / 120 W	ca.2,5 KWh / 270 g	26 kg		•
RMS 8500	821x523x568	90 / 9 lit.	96 lit.	125 W / 120 W	ca.2,5 KWh / 270 g	26 kg	•	
RMS 8501	821x523x568	90 / 9 lit.	96 lit.	125 W / 120 W	ca.2,5 KWh / 270 g	26 kg		•
RMS 8505	821x523x568	90 / 9 lit.	96 lit.	125 W / 120 W	ca.2,5 KWh / 270 g	26 kg		•
RMS 8550	821x523x623	103 /12 lit.	110 lit.	125 W / 120 W	ca.2,6 KWh / 270 g	27 kg	•	
RMS 8551	821x523x623	103 /12 lit.	110 lit.	125 W / 120 W	ca.2,6 KWh / 270 g	27 kg		•
RMS 8555	821x523x623	103 /12 lit.	110 lit.	125 W / 120 W	ca.2,6 KWh / 270 g	27 kg		•
RM 8500	821x523x568	100 / 9 lit.	106 lit.	135 W / 130 W	ca.2,4 KWh / 270 g	28 kg	•	
RM 8501	821x523x568	100 / 9 lit.	106 lit.	135 W / 130 W	ca.2,4 KWh / 270 g	28 kg		•
RM 8505	821x523x568	100 / 9 lit.	106 lit.	135 W / 130 W	ca.2,4 KWh / 270 g	28 kg		•
RM 8550	821x523x623	115 /12 lit.	122 lit.	135 W / 130 W	ca.2,6 KWh / 270 g	30 kg	•	
RM 8551	821x523x623	115 /12 lit.	122 lit.	135 W / 130 W	ca.2,6 KWh / 270 g	30 kg		•
RM 8555	821x523x623	115 /12 lit.	122 lit.	135 W / 130 W	ca.2,6 KWh / 270 g	30 kg		•
RML 8550	1245x523x625	179 /33 lit.	189 lit.	190 W / 170 W	ca.3,2 KWh / 380 g	45 kg	•	
RML 8551	1245x523x625	179 /33 lit.	189 lit.	190 W / 170 W	ca.3,2 KWh / 380 g	45 kg		•
RML 8555	1245x523x625	179 /33 lit.	189 lit.	190 W / 170 W	ca.3,2 KWh / 380 g	45 kg		•
RMSL 8500	1245x523x568	145 /28 lit.	155 lit.	190 W / 170 W	ca.3,2 KWh / 380 g	40 kg	•	
RMSL 8501	1245x523x568	145 /28 lit.	155 lit.	190 W / 170 W	ca.3,2 KWh / 380 g	40 kg		•
RMSL 8505	1245x523x568	145 /28 lit.	155 lit.	190 W / 170 W	ca.3,2 KWh / 380 g	40 kg		•

Subject to technical changes.

*Average consumption measured at an average ambient temperature of 25°C in pursuance of ISO Standard.



Models with flat door

Model	Dimensions H x W x D (mm) Depth incl. door	Gross capacity with freezer compartment	without freezer compartment	Rating details mains/battery	Consumption * electricity/gas over 24hrs	Net weight	Ignition Piezo	Automat
RMS 8500	821x523x541	86 / 9 lit.	92 lit.	125 W / 120 W	ca.2,5 kWh / 270 g	26 kg	•	
RMS 8501	821x523x541	86 / 9 lit.	92 lit.	125 W / 120 W	ca.2,5 kWh / 270 g	26 kg		•
RMS 8505	821x523x541	86 / 9 lit.	92 lit.	125 W / 120 W	ca.2,5 kWh / 270 g	26 kg		•
RMS 8550	821x523x596	99 / 12 lit.	106 lit.	125 W / 120 W	ca.2,6 kWh / 270 g	27 kg	•	
RMS 8551	821x523x596	99 / 12 lit.	106 lit.	125 W / 120 W	ca.2,6 kWh / 270 g	27 kg		•
RMS 8555	821x523x569	99 / 12 lit.	106 lit.	125 W / 120 W	ca.2,6 kWh / 270 g	27 kg		•
RM 8500	821x523x541	96 / 9 lit.	102 lit.	135 W / 130 W	ca.2,4 kWh / 270 g	28 kg	•	
RM 8501	821x523x541	96 / 9 lit.	102 lit.	135 W / 130 W	ca.2,4 kWh / 270 g	28 kg		•
RM 8505	821x523x541	96 / 9 lit.	102 lit.	135 W / 130 W	ca.2,4 kWh / 270 g	28 kg		•
RM 8550	821x523x596	111 / 12 lit.	118 lit.	135 W / 130 W	ca.2,6 kWh / 270 g	30 kg	•	
RM 8551	821x523x596	111 / 12 lit.	118 lit.	135 W / 130 W	ca.2,6 kWh / 270 g	30 kg		•
RM 8555	821x523x596	111 / 12 lit.	118 lit.	135 W / 130 W	ca.2,6 kWh / 270 g	30 kg		•

3.4 Description of refrigerator

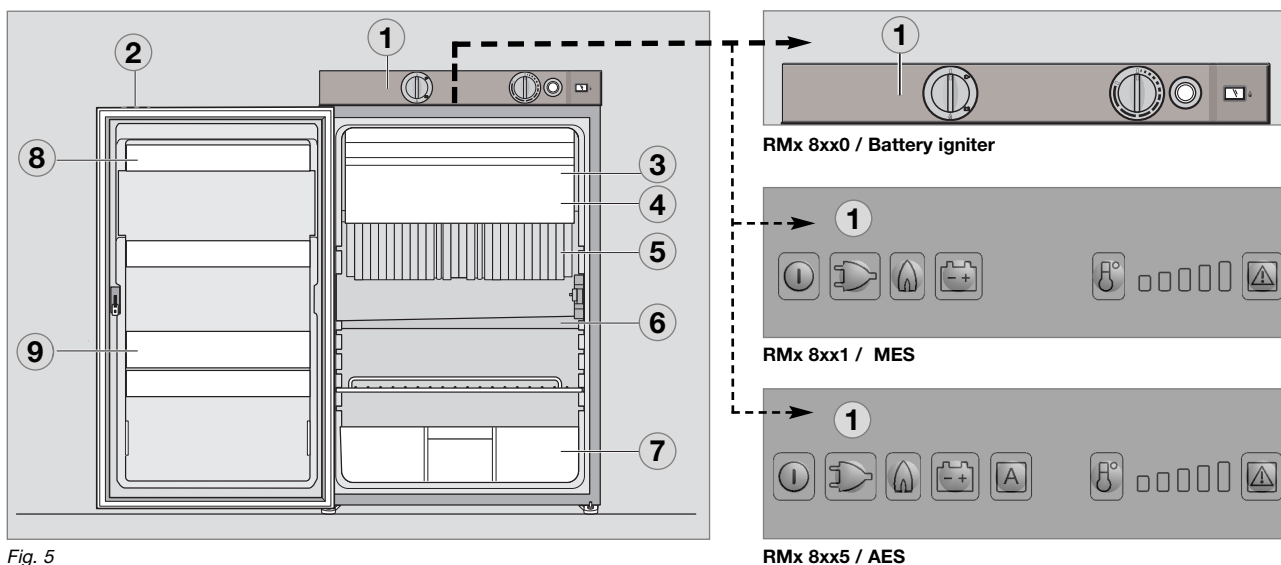

Fig. 5

- ① Operating controls
- ② Door locking button
- ③ Freezer compartment (removable)
- ④ Insertable grid shelf (available as option, to be used when freezer compartment is removed)
- ⑤ Post-evaporator for cooling compartment
- ⑥ Condensation water drain channel
- ⑦ Vegetable bin
- ⑧ Upper door shelf with flap, egg shelf available as option may be inserted
- ⑨ Lower door shelf with bottle holders

4.0 Refrigerator operation

The refrigerator is equipped to operate on three power modes:

- **Mains voltage (230V AC)**
- **Direct-current voltage (12V DC)**
- **Gas (liquid gas propane/butane)**

Select the desired power mode by the **energy selector switch** (battery igniter type models) or the **energy selector button** (MES, AES). Appliances with automatic energy selection (**AES**) are additionally provided with "automatic mode" function. Then the AES system automatically selects the best energy source for each particular situation.



The cooling unit is silent in operation.

When the appliance is first put into operation, there may be a mild odour which will disappear after a few hours.

The refrigerator will take several hours to reach its operating temperature in the cooling compartment. The freezer compartment should be cold about one hour after switching on the refrigerator.

4.1 Cleaning

Before starting up the refrigerator, it is recommended that you clean it inside and repeat this at regular intervals.

Use a soft cloth and lukewarm water with a mild detergent. Then wipe out the appliance with clean water and dry thoroughly.

To avoid material alterations, do not use soap or hard, abrasive or soda-based cleaning agents. Do not allow the door seal to come into contact with oil or grease.

4.2 Maintenance

- **The gas burner must be inspected and cleaned as necessary at least once a year. When using liquefied petroleum gas (tank or refill cylinders) the maintenance interval is reduced to half-yearly or quarterly.**

Keep the evidence of maintenance work carried out on your refrigerator.

- **Work on gas and electrical equipment shall be carried out by qualified personnel only.**

It is recommended that this is carried out by an authorised customer services department.

We recommend maintenance following an extended shutdown of the vehicle. Please contact our customer services.

4.3 Electrical operation

12V-voltage (on-board power supply)

CAUTION!

The refrigerator should only be used in 12VDC-operation while the vehicle's engine is running, otherwise the on-board-battery would be discharged within a few hours!

Mains power (230V)

CAUTION!

This option should only be selected where the supply voltage of the connection for power supply corresponds to the value specified on the data plate. Any difference in values may result in damage the appliance.

4.4 Gas operation (Liquid gas)

- The refrigerator must be operated using liquid gas (propane, butane) (no natural gas or town gas).
- When using LPG gas, please consider that the burner needs cleaning at shorter intervals due to the gas combustion method (2 - 3 times per year recommended).
- In Europe, gas operation is permitted while travelling only on the condition that the gas system of the vehicle is equipped with a hose rupture protection. The national regulations of the respective country must be observed.
- For physical reasons, gas ignition faults could occur starting from an altitude above sea level of approx. 3280 ft. / 1000 m (**No malfunction!**)
- On the initial refrigerator start-up or after a cylinder change, air may be trapped in the gas line. To purge the air from the lines, switch on the refrigerator and any other gas appliances (e.g. stove) for a short time. The gas ignites without delay.
- Each refrigerator with manual ignition is equipped with an automatic flame safety valve which interrupts the gas supply automatically after approx. 30 seconds when the flame has extinguished.



WARNING!

As a basic rule, gas operation is prohibited in petrol stations!

Prior to starting the refrigerator in gas mode :

- Open the gas cylinder valve.
- Open the shut-off valve for gas supply to the refrigerator.

NOTE!

Proceed to the description that applies to **YOUR** model.

4.5 Explanation of operating controls

Manual energy selection / manual ignition (RM 8xx0) battery igniter:

- ① = Power On switch / Energy selector switch
- ② = Temperature controller
- ③ = Battery igniter (gas)
- ④ = Flame indicator (galvanometer)

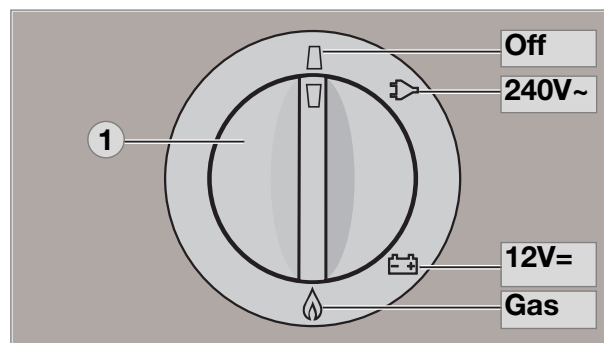

Fig. 6

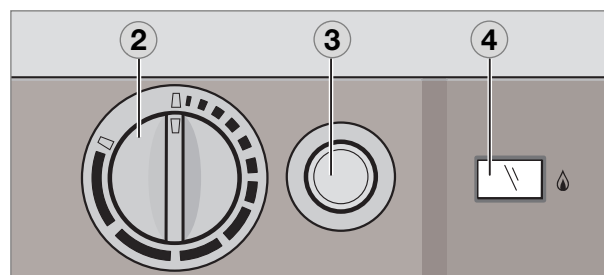

Fig. 7

Manual energy selection / automatic ignition (RM 8xx1) MES :

Fig. 8

- ① = Power **ON/OFF** switch
- ② = Energy selector button 230V ~
- ③ = Energy selector button GAS
- ④ = Energy selector button 12V =
- ⑥ = Temperature level selection
- ⑦ = Temperature level display
- ⑧ = Indicator LED failure /
Reset button GAS FAILURE

Switching ON/OFF

- Switch ON by pressing button (1), 2s
- Switch OFF by pressing button (1), > 2s

230V AC operation

- Select "Mains voltage" by pressing button (2)
- Set temperature step by pressing button (6)

12V DC operation (vehicle's battery)

- Select "Battery voltage" by pressing button (4)
- Set temperature step by pressing button (6)

Gas operation

- Select "Gas" by pressing button (3)
- Set temperature step by pressing button (6)

Automatic energy selection / automatic ignition (RM 8xx5) AES :

Fig. 9

- ① = Power **ON/OFF** switch
- ② = Energy selector button 230V ~
- ③ = Energy selector button GAS
- ④ = Energy selector button 12V =
- ⑤ = Selector button "AUTOMATIC"
- ⑥ = Temperature level selection
- ⑦ = Temperature level display
- ⑧ = Indicator LED failure /
Reset button GAS FAILURE

Switching ON/OFF

- Switch ON by pressing button (1), 2s
- Switch OFF by pressing button (1), > 2s

Manual operation

- Select energy source with buttons (2,3,4)
- Set temperature step by pressing button (6)

Automatic operation

- Change over to "Automatic" with button (5)
Automatical energy selection (if available)
Sequence of priority: 1.) Solar (12V -)
2.) 240V ~
3.) 12V -
4.) Liquid gas
- Set temperature step by pressing button (6)

4.6 RM 8xx0 models

Appliances with battery igniter (manual energy selection)

4.6.1 Electrical operation

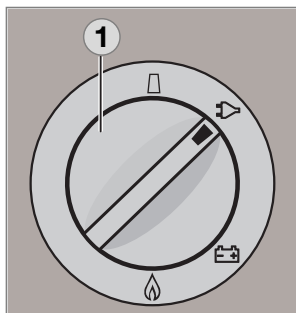

Fig. 10

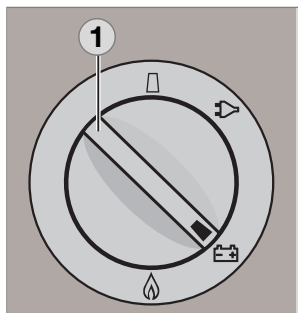



Fig. 11

Switch on the appliance by turning the energy selection switch **(1)** clockwise to position :

 230V operation,

 12V operation.

4.6.2 Gas operation (Liquid gas)

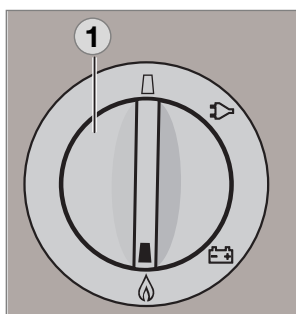

Fig. 12

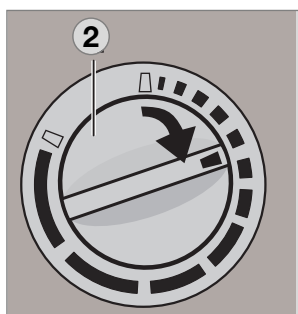



Fig. 13

1. Turn the rotary selector switch **(1)** to position .
2. Turn the temperature selector **(2)** clockwise and push. Keep the controller button depressed.

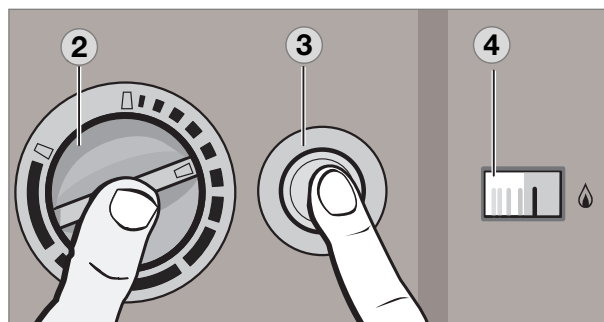

Fig. 14

3. Then, press knob **(3)** of battery igniter down and keep it depressed. The ignition process is activated automatically.
4. Once the flame ignites, the pointer of galvanometer **(4)** begins moving into the green range. The refrigerator is operational. Keep knob **(2)** depressed for approx. 15 seconds and finally release it.

4.6.3 Setting of cooling compartment temperature

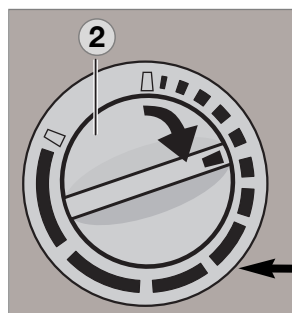

Fig. 15

Select the desired cooling compartment temperature by turning the rotary knob **(2)**.

The scale starts with **MIN** position (small bar = highest temperature) and climbs up to **MAX** position (large bar = lowest temperature).

Note: The temperature levels do not relate to absolute temperature values.

12V: The refrigerator operates without thermostatic control (continuous operation).

4.7 RM 8xx1 models

MES appliances (manual energy selection)

4.7.1 Electrical operation

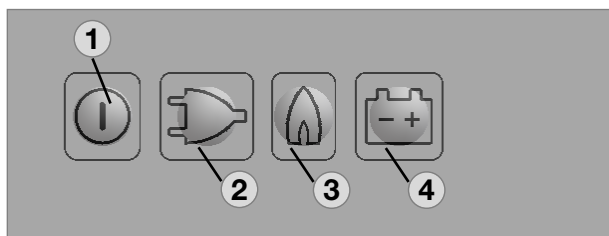

Fig. 16

To start the refrigerator, press button **(1)** for **2 seconds**.

The refrigerator starts with the last selected type of energy.

240V operation :

Press button **(2)** :



12V operation :

Press button **(4)** :



4.7.1 Gas operation

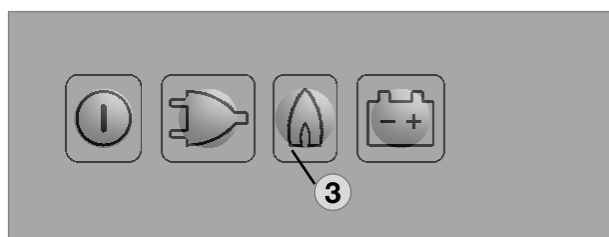

Fig. 17

Gas operation :

Press button **(3)** :



The ignition process is activated automatically by means of an automatic igniter.



The flame extinguishes after reaching the pre-set cooling compartment temperature and ignites again if the cooling compartment temperature increases again. If the flame is not lit after the first ignition attempt, the automatic igniter repeats the ignition twice (duration 30 s) at time intervals of 2 minutes. If the flame is not lit afterwards, a fault is indicated.

4.7.2 Setting of cooling compartment temperature

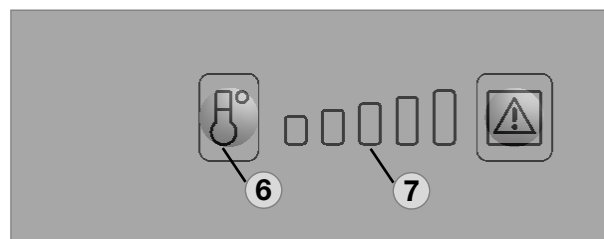

Fig. 18

Select the desired cooling compartment temperature by pressing button **(6)**.

The LED display **(7)** of the selected temperature setting is illuminated.

The scale starts with **MIN position** at the left LED position (small bar = highest temperature) and climbs up to **MAX position** at the right LED position (large bar = lowest temperature). Note: The temperature levels do not relate to absolute temperature values.

4.8 RM 8xx5 models

AES appliances

(manual + automatic energy selection)

4.8.1 Manual operation



Abb. 19

To start the refrigerator, press button **(1)** for **2 seconds**.

The refrigerator starts with the last selected type of energy.

240V operation :

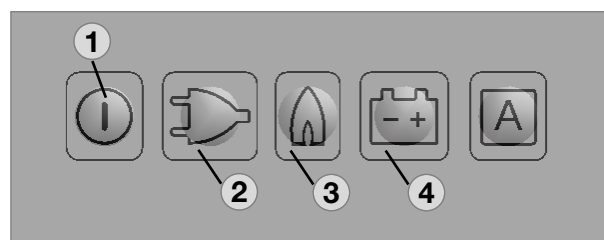
Press button **(2)** :



12V operation :

Press button **(4)** :



Gas operation :

Press button **(3)** :



4.8.2 Automatic operation

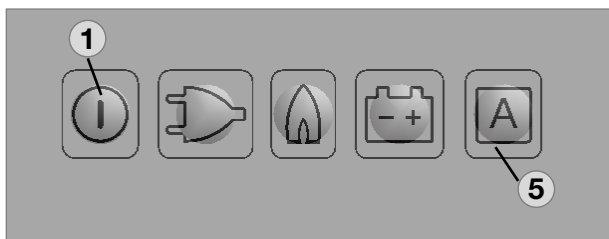

Fig. 20

To start the refrigerator, press button **(1)** for **2 seconds**.

The refrigerator starts with the last selected type of energy.

Automatic operation :

Press button **(5) : A**

Upon switching on, the electronics **automatically** selects one of the three possible energy types: **240V - 12V - liquid gas**. The control electronics automatically ensures that the refrigerator is supplied with the optimum source of energy in each respective case.

Sequence of priority:

- 1.) Solar (12V -)
- 2.) 240V ~
- 3.) 12V -
- 4.) Liquid gas



If sufficient mains voltage is available (more than 195 V), this power source is selected as prime option. If a solar system capable of powering the refrigerator is installed, the solar 12V supply takes priority.

The 12V operation is otherwise only effective while the engine is running.

According to the sequence of priority the electronics selects **GAS** as energy source only, if both of the electrical energy source are not available.

Manual operation is possible at any time.

4.8.3 Setting of cooling compartment temperature

see point "4.7.2"

4.8.4 Refuelling while in AES mode operation



In order to prevent unintended switching to gas operation during refuelling, the electronic system starts gas operation of the refrigerator after the motor has been turned off for 15 minutes. During this period the appliance is ready for operation ("stand-by"). The temperature level LEDs do not light then while all other indicators remain active.



WARNING!

The use of unshielded flames is prohibited in petrol station environments.

Should the refuelling stop last longer than 15 minutes, the refrigerator has to be switched off or switched over to another energy type.

4.8.5 Additional features (MES / AES)

- The brightness of the display reduces after a few seconds if no other buttons are pressed. The indicator lights again if a button is pressed. Press the button again to activate the required function.
- Failures are indicated by flashing of the failure indicator LED.
- Should the door be kept open for too long (more than 2 minutes), an acoustic signal is initiated (pulsing whistle tone).
- Should the electronic control detect any failure, an acoustic signal will sound (pulsing whistle tone). At the same time the display starts flashing (for trouble-shooting, please refer to *section 4.21*).

4.9 Gas operation with internal batteries (optional)

An optional battery compartment in the electronics case for internal (self-contained) power supply of the electronics is available for the model variants RM 8xx1 and RM 8xx5 (appliances with electronics).

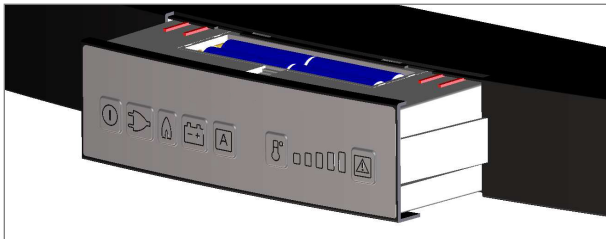

Battery compartment

Fig. 21

Load the battery compartment with batteries (8 x AA 1.5 V) before operating the refrigerator.

All operating modes can be selected while the on-board 12 V DC power supply is active. The internal voltage is disconnected.

If the on-board 12 V DC power supply is not present or there is an interruption of the mains power supply during operation, the electronics automatically switch to the internal (battery) power supply.

The refrigerator can now only be operated in the **gas mode**.

All LED indicators except the **GAS LED** are not lit during operation with internal batteries. The **GAS LED** flashes every **15 seconds**.

If a button is pressed, the temperature level LEDs (7) also light.

If the battery voltage is too low, an acoustic signal (whistle tone) sounds every 15 seconds. Then replace the batteries in the battery compartment.

4.9.1 Inserting / changing the batteries

- Switch off the refrigerator, as described in section 4.17 Shutting of the refrigerator.

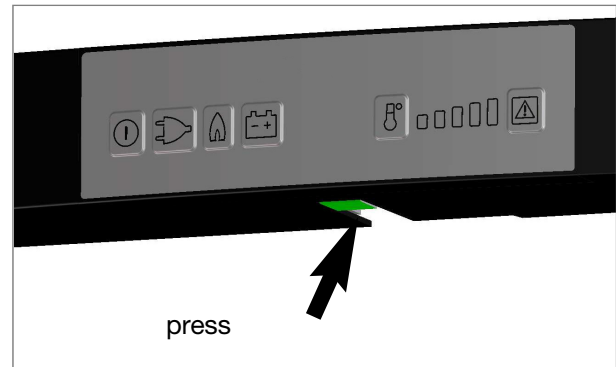

Opening battery compartment

Fig. 22

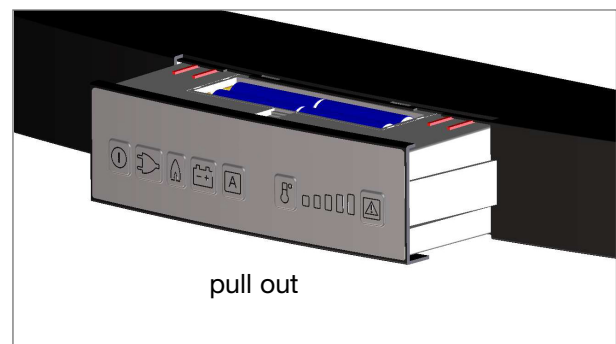

Fig. 23



Batteries (8 x AA 1.5V) are not included !

CAUTION!

- Observe the correct polarity !
- Do not connect non-rechargeable batteries to a charger.
- Remove rechargeable batteries from the battery compartment before charging.
- Avoid short circuits on the contacts in the battery compartment!
- Remove discharged batteries.
- Remove the batteries from the battery compartment if the refrigerator will not be used for a long time.
- Do not mix different types of batteries.

4.10 Door locking

 **CAUTION!**
 As a basic rule, shut and lock the refrigerator before you start your journey!



Fig. 24

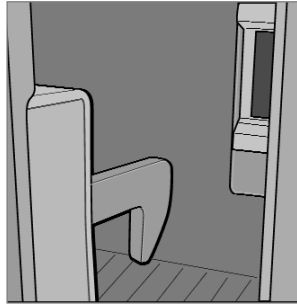

Fig. 25

Open the door by pressing the locking button and pull open (see Fig. 24).

Shut the door again by pushing it to close. The snapping into the lock can be heard.

While the vehicle is parked, the locking hook may be fixed to facilitate opening of the door (Fig. 26-27).

4.10.1 Fastening and releasing the door lock hook when parking the vehicle

If the vehicle is parked for a longer period of time, the locking hook may be clamped by means of a lockbar. The door may now be opened by just pulling it without need of pressing the locking button.

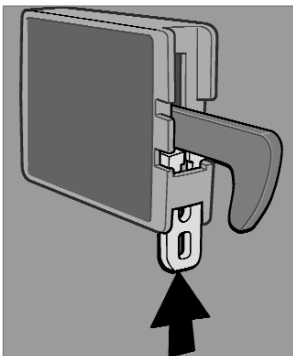

Fastening

Fig. 26

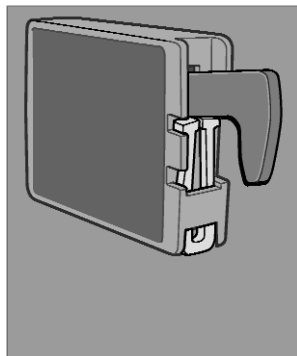
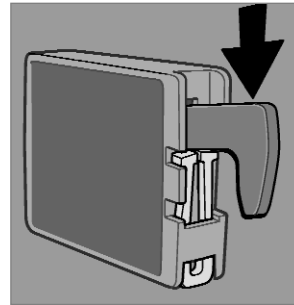

Fig. 27



Releasing

Fig. 28

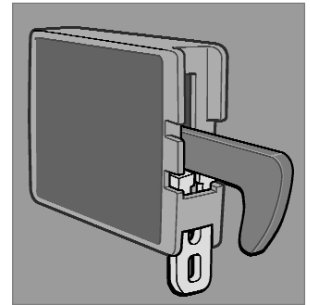

Fig. 29

4.11 Lighting

The interior lighting is controlled using a door contact. Should the door be kept open more than 2 minutes, an acoustic signal is initiated (pulsing whistle tone).

(except for models with battery igniter).

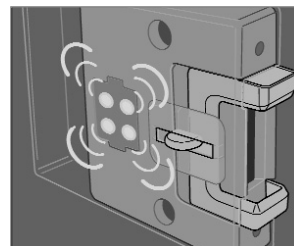

Fig. 30



Please contact the authorized Dometic Service if a failure occurs.

4.12 Positioning the storage racks

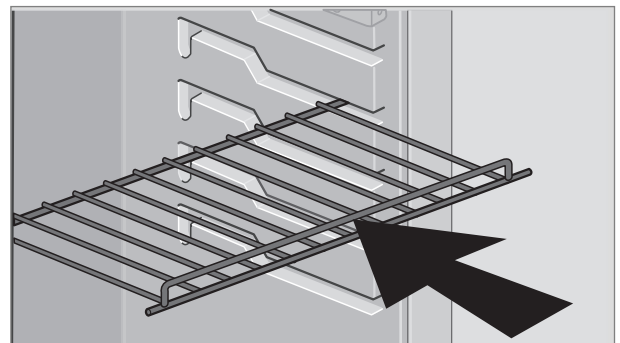

Fig. 31

The storage racks may be pulled out by smoothly lifting them and may be positioned as desired.

4.13 Removable freezer compartment

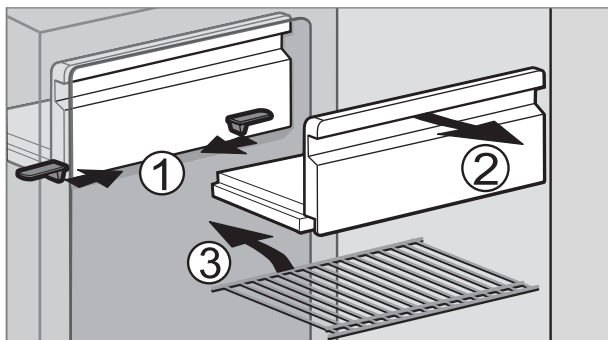

Fig. 32

To enlarge the cooling compartment, just remove the freezer compartment.

1. Unlock the freezer compartment on both sides.

2. Pull the freezer compartment out.

Store the freezer compartment safely in order to prevent damage



Once the freezer compartment is removed, an additional storage rack (3.) may be installed. The storage rack is a piece of extra equipment and may be obtained from **Dometic** dealer service network.

4.14 Exchange of the igniter's battery

Appliances with battery igniter (RM 8xx0)

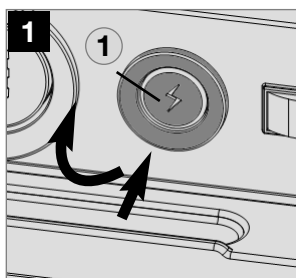

Fig. 33

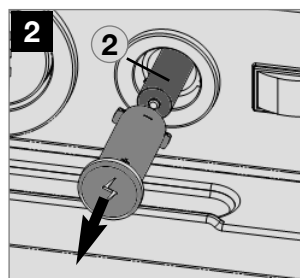

Fig. 34

Unlock the battery (2) by depressing and turning the button (1) approx. 90° clockwise (by means of a suitable screw driver). After removing the cap, the battery (1.5 V **AAA/R3/Micro**) can be removed and replaced. **Observe correct polarity!**

4.15 Storing food and making ice cubes

4.15.1 Storing products in the cooling compartment

- Switch the refrigerator on approx. 12 hours before filling it.
- Always store pre-cooled foods in the refrigerator. Make sure that the food is well cooled when it is bought and also when transporting it. Use insulated cooling bags.
- Open the refrigerator door only for a short period of time when removing products.
- Products must be packed - best of all in closed containers, wrapped in aluminium foil or similar - and stored separately from each other, in order to prevent drying out or odours.
- Allow foods that have been warmed up to cool down before storing.
- Avoid storing products in the refrigerator that could emit volatile flammable gases.
- Do not overfill the storage grids and compartments to prevent obstructing the internal air circulation.
- Maintain a clearance of approx. 5 - 10 mm between chilled products and post-evaporator ("cooling fins").
- Do not expose the refrigerator to direct sunlight. Please bear in mind that the temperature inside a closed vehicle increases sharply if exposed to sunlight and that this can reduce the efficiency of the refrigerator.
- Ensure that air circulation of the cooling unit is not obstructed. Keep the ventilation grilles free from obstructions.

4.15.2 Storing products in the freezer compartment

- Do not keep carbonated drinks in the freezer.

- The freezer compartment is suitable for making ice cubes and for short-term storage of frozen food. It is not suitable as a means of freezing foods.

When ambient temperatures are lower than +10°C and the refrigerator is exposed to these temperatures for extended periods of time, an even regulation of freezer temperature cannot be guaranteed for system-related reasons. This can cause the temperature in the freezer to rise and the stored goods to melt.

4.15.3 Refrigerator compartments

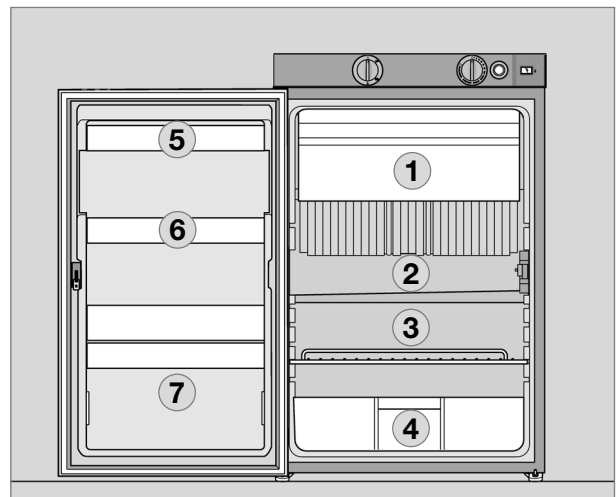

Fig. 37

- 1 Freezer compartment :**
already frozen food (deep-frozen food)
- 2 Middle compartment:**
Dairy products, convenience food
- 3 Bottom compartment:**
Meat, fish, food for defrosting
- 4 Vegetable compartment:**
Salads, vegetables, fruit
- 5 Top door shelf:**
Eggs, butter
- 6 Middle door shelf:**
Cans, dressings, ketchup, jam
- 7 Bottom door shelf (drinks compartment):**
Drinks in bottles or bags

4.15.4 Making ice cubes

Ice cubes are best frozen overnight. At night, the refrigerator has less work to do and the unit has more reserves.



Fig. 38

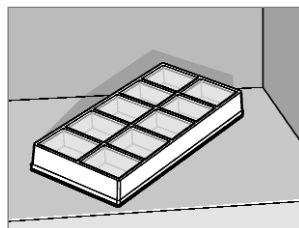

Fig. 39

1. Fill the ice cube tray with drinking water.
2. Place the ice cube tray in the freezer compartment.



4.16 Shutting off the refrigerator

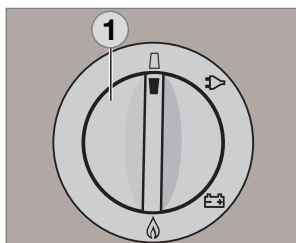

Fig. 40

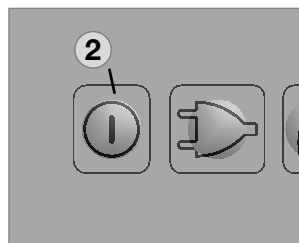

Fig. 41

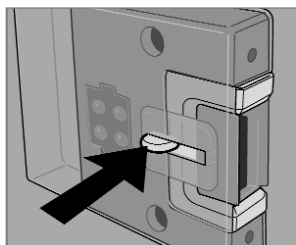

Fig. 42

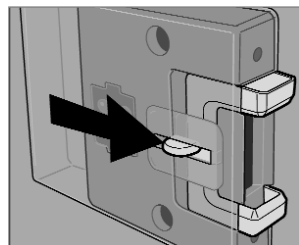

Fig. 43

- For battery igniter models, set energy selector switch (1) to position "OFF". The appliance is switched off (Fig. 40).
- Switch off MES and AES models by pressing button (2). Keep button (2) pressed for 3 seconds. The display disappears

and the appliance is fully switched off (Fig. 40).

- Release the locking mechanism of the door lock by pushing it and shift it to the front. If the door is shut in this position, a small gap is nevertheless kept open to prevent formation of mildew.
- If the refrigerator is to be taken out of service for an extended period of time, close the onboard shut-off valve and the cylinder valve .

4.17 Defrosting

As time goes by, frost builds up on the fins inside the refrigerator. A layer of frost thicker on one side may occur and does not represent a malfunction. When this layer of frost is about 3 mm thick, the refrigerator should be defrosted.

- Switch off the refrigerator, as described in section 4.16 *Shutting of the refrigerator*.
- Remove all food and the ice cube tray.
- Leave the refrigerator door open to allow air to enter and to prevent formation of mildew.
- After defrosting (freezer compartment and fins free of frost), wipe both cooling compartments dry with a cloth.

Note: Water thawing in the main compartment of the refrigerator runs into an appropriate container at the back of the refrigerator. From there, the water evaporates.

CAUTION!

The layer of ice must never be removed forcibly, nor may defrosting be accelerated using a heat source!

4.18 Changing the decor panel

Model RMS 84xx, RM 8xxx, RM(S)L 8xxx (with frame)

- Remove the lateral ledge (1) the door (ledge is attached, not screwed).
- Shift decor panel (2) away from the door and insert the new decor panel. Re-attach ledge (1) .

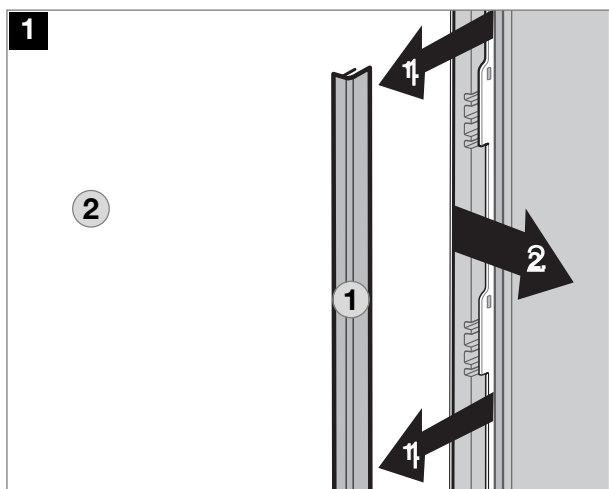

Fig. 44

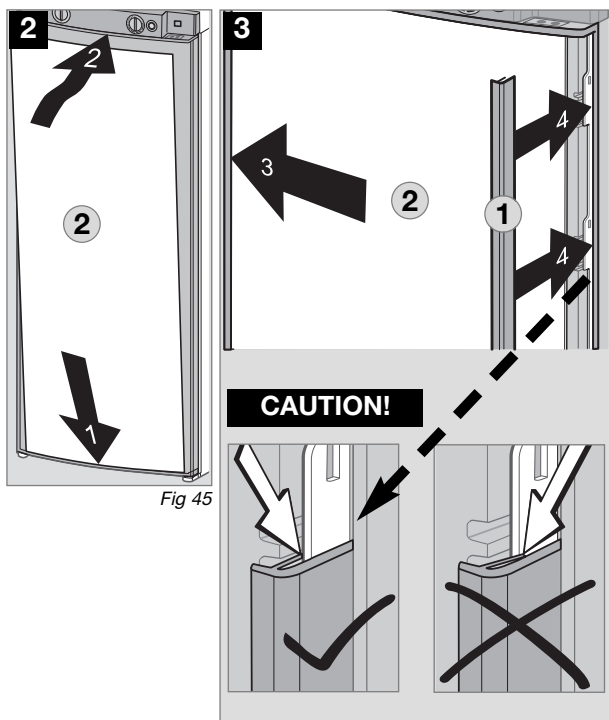

Fig. 46

Modell RMx(L) 8xxx (frameless decor panel)

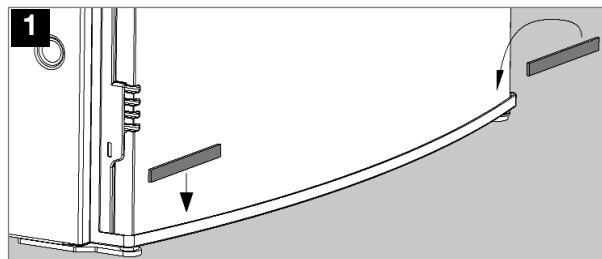

Fig. 47

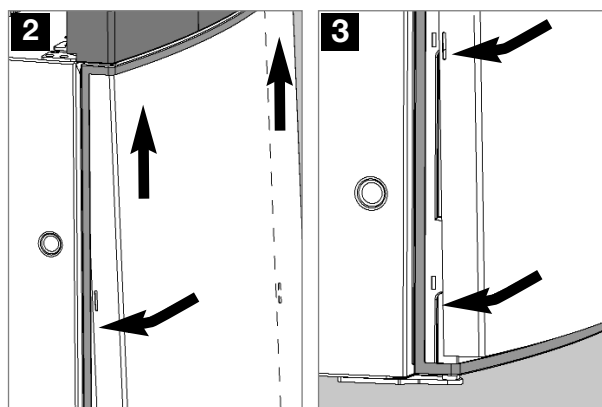

Fig. 48

Fig. 49

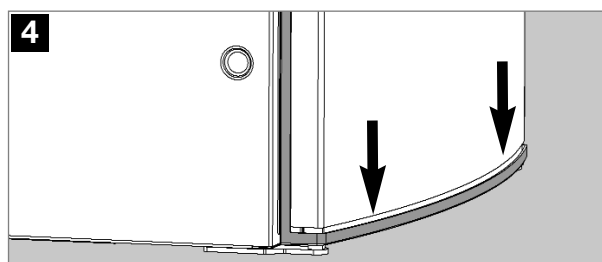

Fig. 50

Decor panel dimensions (frame) :

RMS 84xx, RM 8xxx

Casing width 486 mm

Height	Width	Thickness
743 +/- 0.5 mm	472 +/- 0.5 mm	max. 2.2 mm

Casing width 523 mm

Height	Width	Thickness
743 +/- 0.5 mm	510,5 +/- 1 mm	max. 2.2 mm

RM(S)L 8xxx

Casing width 523 mm

Height	Width	Thickness
1169.5 +/- 1 mm	507.5 +/- 1 mm	max. 1.5 +/- 1 mm

4.19 Trouble-shooting

Failure: The refrigerator does not cool sufficiently.

Possible cause	Action you can take
<ul style="list-style-type: none"> - Inadequate ventilation to the unit. - Thermostat setting is too low. - The condenser is heavily frosted. - Too much warm food has been stored inside within short period of time. - The appliance has been running for only a short period of time. - Ambient temperatures too high. 	<ul style="list-style-type: none"> - Check that ventilation grilles are not covered. - Set thermostat to a higher level. - Check that the refrigerator door closes properly. - Allow warm food to cool down before storage. - Check whether the cooling compartment works after approx. 4 - 5 hours. - Regularly remove ventilation grilles.

Failure: The refrigerator does not cool in gas operation mode.

Possible cause	Action you can take
<ul style="list-style-type: none"> - Gas cylinder empty. - Is the upstream shut-off device open ? - Air in the gas pipe ? 	<ul style="list-style-type: none"> - Change gas cylinder. - Open shut-off device. - Switch off the appliance and start again. Repeat this procedure 3 - 4 times, if necessary

Failure: The refrigerator does not cool in 12V operation.

Possible cause	Action you can take
<ul style="list-style-type: none"> - On-board fuse defective. - On-board battery discharged. - Engine not running. - Heating element defective (please also refer to failure indication). 	<ul style="list-style-type: none"> - Fit new fuse. - Check battery, charge it. - Start engine. - Please inform the Dometic Customer Service

Failure: The refrigerator does not cool in 240V operation.

Possible cause	Action you can take
<ul style="list-style-type: none"> - On-board fuse defective. - Vehicle not connected to mains supply voltage. - AES: Gas operation despite connection to the mains supply voltage? - Heating element defective (please also refer to failure indication). 	<ul style="list-style-type: none"> - Fit new fuse. - Make a connection to a mains power supply. - Appliance switches to gas operation due to insufficient mains supply voltage (automatically switches back to 230V operation). - Please inform the Dometic Customer Service.

4.20 Information on failure display and trouble-shooting

- Refrigerators with an electronics system (MES, AES) indicate the occurrence of a malfunction by the LED or display flashing.
- If a malfunction occurs, the indicator LED "Failure" (8) flashes simultaneously. In the case of AES models an acoustic alarm sounds.

Before notifying the authorised Service Center, please check whether:

- the instructions in section "Operating the refrigerator" have been observed.
- the refrigerator stands level.
- it is possible to operate the refrigerator with any available power source.

4.20.1 Status indicators



MES

Fig. 51

- 1 = Button ON / OFF
- 2 = Energy selector switch 230 V AC
- 3 = Energy selector switch GAS
- 4 = Energy selector switch 12V DC



AES





Fig. 52

- 5 = selector switch "AUTOMATIC"
- 6 = temperature level button
- 7 = temperature level display
- 8 = fault LED / GAS FAULT reset button

Operation with on-board 12 V power supply

Indicator	Fault	Remedy
flashing + acoustic signal 20 s	230V mode: "230V" not available or voltage too low	Check mains power connection, mains voltage, fuse
flashing + acoustic signal 20 s	12V mode: „: "12 V" not available or voltage too low	Check 12 V connection, on-board battery, fuse AES: Check D+ signal
flashing + acoustic signal 20 s	GAS/Automatic mode: Flame not ignited	Check gas supply (gas bottle, gas valve) Press the button after clearing the fault.
Acoustic signal, 15 s, at 2 minute intervals	Interior lighting is switched on	Close door, check door contact
flashing + acoustic signal 20 s	230V mode: 230V heating element defective	Arrange replacement of 230V heating element, contact Customer Service
flashing + acoustic signal 20 s	12V mode: 12V heating element defective	Arrange replacement of 12V heating element, contact Customer Service
flashing	Temperature sensor without contact or defective	contact Customer Service
flashing + acoustic signal 20 s	Burner defective or cooling unit defective	Check burner, burner nozzles, if necessary contact Customer Service and arrange replacement

Operation with batteries (internal power supply)

Indicator	Fault	Remedy
③  flashing ⑧  brightly	Flame not ignited	Check gas supply (gas bottle, gas valve) Press the  button after clearing the fault.
③  flashing ⑦  brightly	Burner defective or cooling unit defective	Check burner, burner nozzles, if necessary contact Customer Service and arrange replacement
Acoustic signal at 15 second intervals	Undervoltage detection (internal batteries)	Replace batteries
Automatic switching from external to internal power supply does not function (absence of the on-board 12 V power supply for the electronics)	Refrigerator does not function; gas operation not possible although the batteries are inserted.	Switch off the refrigerator and start again. The on-board power supply was interrupted during the starting of the gas operation. Note: No automatic switching is performed during the ignition.

GERMANY**Dometic WAECO International GmbH**

Hollefeldstraße 63 · D-48282 Emsdetten

☎ +49 (0) 2572 879-195 · 📠 +49 (0) 2572 879-322

Mail: info@dometic-waeco.de

www.dometic.com**AUSTRALIA****Dometic Australia Pty. Ltd.**1 John Duncan Court
Varsity Lakes QLD 4227

☎ 1800 212121

☎ +61 7 55076001

Mail: sales@dometic.com.au

AUSTRIA**Dometic Austria GmbH**

Neudorferstraße 108

A-2353 Guntramsdorf

☎ +43 2236 908070

☎ +43 2236 90807060

Mail: info@dometic.at

BENELUX**Dometic Branch Office Belgium**

Zincstraat 3

B-1500 Halle

☎ +32 2 3598040

☎ +32 2 3598050

Mail: info@dometic.be

BRAZIL**Dometic DO Brasil LTDA**

Avenida Paulista 1754, conj. 111

SP 01310-920 Sao Paulo

☎ +55 11 3251 3352

☎ +55 11 3251 3362

Mail: info@dometic.com.br

DENMARK**Dometic Denmark A/S**

Nordensvej 15, Taulov

DK-7000 Fredericia

☎ +45 75585966

☎ +45 75586307

Mail: info@dometic.dk

FINLAND**Dometic Finland OY**

Mestarintie 4

FIN-01730 Vantaa

☎ +358 20 7413220

☎ +358 9 7593700

Mail: info@dometic.fi

FRANCE**Dometic SAS**

ZA du Pré de la Dame Jeanne

B.P. 5

F-60128 Plailly

☎ +33 3 44633525

☎ +33 3 44633518

Mail: vehiculesdeloisirs@dometic.fr

HONG KONG**Dometic Group Asia Pacific**

Suites 2207-11 · 22/F · Tower 1

The Gateway · 25 Canton Road,

Tsim Sha Tsui · Kowloon

☎ +852 2 4611386

☎ +852 2 4665553

Mail: info@waeco.com.hk

HUNGARY**Dometic Zrt. Sales Office**

Kerékgyártó u. 5.

H-1147 Budapest

☎ +36 1 468 4400

☎ +36 1 468 4401

Mail: budapest@dometic.hu

ITALY**Dometic Italy S.r.l.**

Via Virgilio, 3

I-47122 Forlì (FC)

☎ +39 0543 754901

☎ +39 0543 754983

Mail: vendite@dometic.it

JAPAN**Dometic KK**

Maekawa-Shibaura, Bldg. 2

2-13-9 Shibaura Minato-ku

Tokyo 108-0023

☎ +81 3 5445 3333

☎ +81 3 5445 3339

Mail: info@dometic.jp

MEXICO**Dometic Mx, S. de R. L. de C. V.**

Circuito Médicos No. 6 Local 1

Colonia Ciudad Satélite

CP 53100 Naucalpan de Juárez

Estado de México

☎ +52 55 5374 4108

☎ +52 55 5393 4683

Mail: info@dometic.com.mx

NETHERLANDS**Dometic Benelux B.V.**

Ecustraat 3

NL-4879 NP Etten-Leur

☎ +31 76 5029000

☎ +31 76 5029019

Mail: info@dometic.nl

NEW ZEALAND**Dometic New Zealand Ltd.**

PO Box 12011

Penrose

Auckland 1642

☎ +64 9 622 1490

☎ +64 9 622 1573

Mail: customerservices@dometic.co.nz

NORWAY**Dometic Norway AS**

Østerøyveien 46

N-3232 Sandefjord

☎ +47 33428450

☎ +47 33428459

Mail: firmapost@dometic.no

POLAND**Dometic Poland Sp. z o.o.**

Ul. Puławska 435A

PL-02-801 Warszawa

☎ +48 22 414 3200

☎ +48 22 414 3201

Mail: info@dometic.pl

PORTUGAL**Dometic Spain, S.L.**

Branch Office em Portugal

Rot. de São Gonçalo nº 1 – Esc. 12

2775-399 Carcavelos

☎ +351 219 244 173

☎ +351 219 243 206

Mail: info@dometic.pt

RUSSIA**Dometic RUS LLC**

Komsomolskaya square 6-1

RU-107140 Moscow

☎ +7 495 780 79 39

☎ +7 495 916 56 53

Mail: info@dometic.ru

SINGAPORE**Dometic Pte Ltd**

18 Boon Lay Way 06-140 Trade Hub 21

Singapore 609966

☎ +65 6795 3177

☎ +65 6862 6620

Mail: dometic@dometic.com.sg

SLOVAKIA**Dometic Slovakia s.r.o. Sales Office Bratislava**

Nádražná 34/A

900 28 Ivánka pri Dunaji

☎/☎ +421 2 45 529 680

Mail: bratislava@dometic.com

SOUTH AFRICA**Dometic (Pty) Ltd.****Regional Office****South Africa & Sub-Saharan Africa**

2 Avalon Road

West Lake View Ext 11

Modderfontein 1645

Johannesburg

☎ +27 11 4504978

☎ +27 11 4504976

Mail: info@dometic.co.za

SPAIN**Dometic Spain S.L.**

Avda. Sierra del Guadarrama, 16

E-28691 Villanueva de la Cañada

Madrid

☎ +34 902 111 042

☎ +34 900 100 245

Mail: info@dometic.es

SWEDEN**Dometic Scandinavia AB**

Gustaf Melins gata 7

S-42131 Västra Frölunda

☎ +46 31 7341100

☎ +46 31 7341101

Mail: info@dometicgroup.se

SWITZERLAND**Dometic Switzerland AG**

Riedackerstrasse 7a

CH-8153 Rümlang

☎ +41 44 8187171

☎ +41 44 8187191

Mail: info@dometic.ch

UNITED ARAB EMIRATES**Dometic Middle East FZCO**

P. O. Box 17860

S-D 6, Jebel Ali Freezone

Dubai

☎ +971 4 883 3858

☎ +971 4 883 3868

Mail: info@dometic.ae

UNITED KINGDOM**Dometic UK Ltd.**

Dometic House, The Brewery

Blandford St. Mary

Dorset DT11 9LS

☎ +44 344 626 0133

☎ +44 344 626 0143

Mail: customerservices@dometic.co.uk

USA**Dometic RV Division**

1120 North Main Street

Elkhart, IN 46515

☎ +1 574-264-2131